

# PUZZLEBOMB

## SHIKAKU

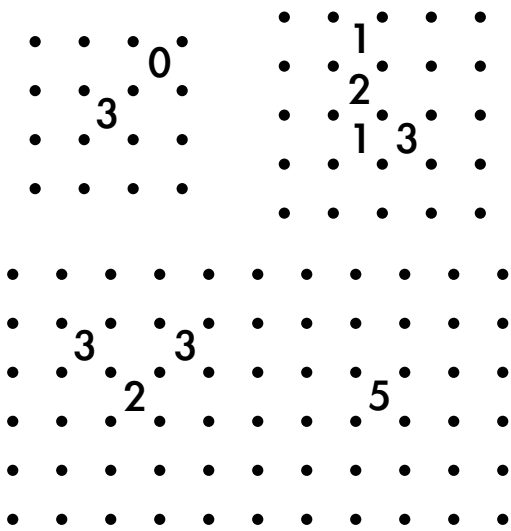

- Draw squares on the grid so that each numeral correctly indicates the number of squares inside which it lies.
- Squares may be any size but no two squares can share any section of line. Every square must contain a numeral.
- When overlapping squares form new squares, these new squares need not contain numerals, but count towards totals.

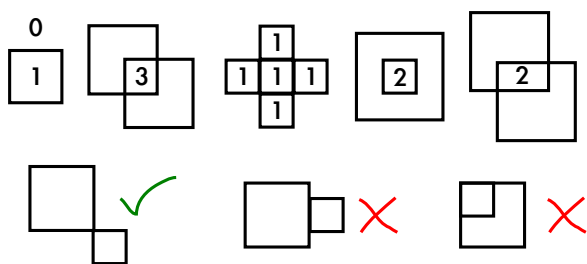

SHIKAKU: invented by @andrew\_taylor.

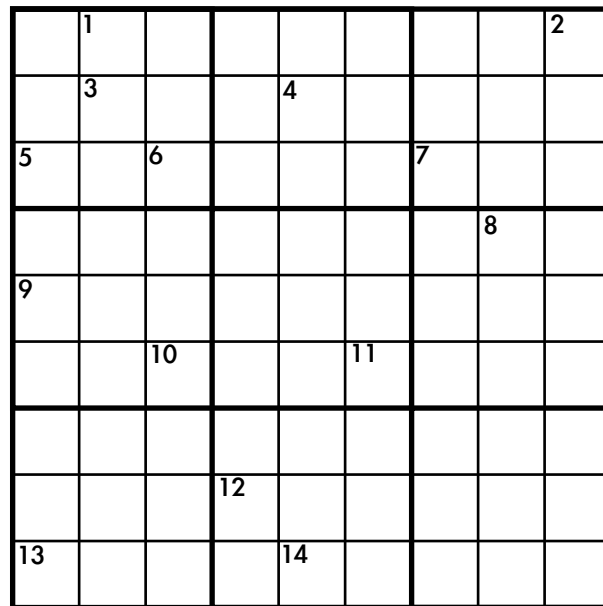

The grid is a Sudoku in nine letters. The clues will help you work out what the letters are. 9 across is unclued (9).

**ACROSS**

1. Where the beast rests (4)
3. Herb (3)
10. Commercial vehicle (3)
12. Japanese chimera (3)
13. Bright and centrally located (3)
14. Symbol of authority (4)

**DOWN**

2. Aggressive noise (5)
4. Out of place (5)
5. Of nerves (6)
6. Long, thin section (6)
7. Withdrawn (7)
8. Fruitless (4)
11. Place at rest (3)

## CLUDOKU

CLUDOKU: Copyright Richard Crawford (@RickCrawf).

## APIS CLUES

Here are five cryptic crossword clues. You must solve the clues, then find the connection between the answers.

APIS CLUES: devised by @apisclues.

1. Victory after radical turn for naturalist (6)
2. Ondaatje suspected of harbouring prophet (5)
3. PM: you are briefly stammering 'Cold outside' (9)
4. Poet losing time from wine (5)
5. No.2's follower made angel queer (9)

# PUZZLEBOMB

1			2
3	4		
5			
6			

Each clue contains a definition of the answer and a jumble of the answer straddling a space between two words. Of the remaining words, one from each clue is similar in meaning to one of a set of thematic names. Five of the entries (starred) must be entered jumbled. A thematic item, doubled and hung, determines a transformation which must be applied to the grid, revealing an appropriate message (15 letters), which should be highlighted.

**Across**

- 1. Was victorious despite silly miscalculation with bishop (3)
- 3.\* Retiring alongside hard-hit workmate (4)
- 5.\* Bones found in Tenerife sand dune (4)
- 6. Song made fair Alice sniffly (4)

**Down**

- 1.\* Edith Piaf twice beset by angry fan (4)
- 2.\* Undersea wildlife overwhelms delighted diver (4)
- 4.\* Knight's charger is lethargic (3)

## TINY LISTENER

TINY LISTENER: compiled by @apaultaylor & @stecks.

- 1. Scandinavian ruler almost completely engrossed by middlingly lavish herring's tail (6)
- 2. Measure three-and-a-bit about group of countries (6)
- 3. Hugo perhaps briefly blue after triumph (7)
- 4. Chance for melody (7)
- 5. Look after insect queen (6)

## HEIHOU

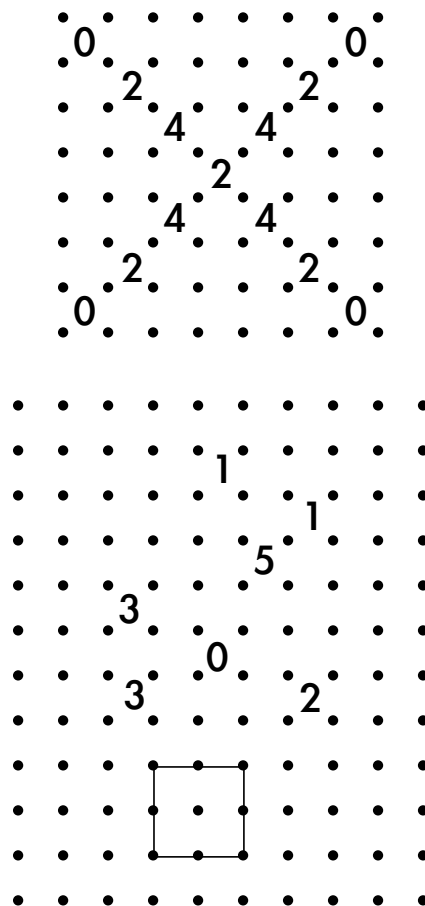

SHIKAKU is now HEIHOU! For the rules & simpler examples, see SHIKAKU in PB#1.

HEIHOU: invented by @andrew\_taylor.

Here are five cryptic crossword clues. You must solve the clues, then find the connection between the answers.

## APIS CLUES

APIS CLUES: devised by @apisclues.

# PUZZLEBOMB

Shaded entries are unclued, but the sum of their proper factors is also present as an unclued entry in the grid. All entries are distinct, and no entry starts with a zero.

## ACROSS

- 1. Prime
- 4.  $(18dn \times 11ac) + 15ac$
- 8. Prime
- 11. 21ac backwards
- 12. Greater than 21dn
- 15. Factor of  $(18dn - 10)$
- 17. (Principal) square root of  $(16dn + 21)$
- 21. Triple the sum of the digits of 8ac
- 22.  $1dn + 16dn - (10 \times 23ac) - 82$
- 23.  $10 \times 15ac$

## DOWN

- 2. Prime bigger than 8ac
- 3.  $9ac + 10$
- 4. A ninth power
- 6.  $Square - 11ac - 15ac$
- 7.  $13ac + 8$
- 10. Prime  $\times 10$
- 14. Multiple of 9
- 17. Cube
- 19. Multiple of 9
- 21. Product of the digits of 8ac

1	2	3	4	5	6	7
8		9				
	10				11	
12		13		14	15	16
17		18	19			
	20				21	
22				23		

NUMBERWARG: devised by @apaultaylor and @stecks.

# NUMBERWARG

## APIS CLUES

Here are five cryptic crossword clues. You must solve the clues, then find the connection between the answers.

APIS CLUES: devised by @apisclues.

- 1. Musical in which Nazis are on the tail of revolutionary (5)
- 2. Gold cent stolen from plate before Monday's lesson (6)
- 3. Lost fellow's heartless, it's reported (4)
- 4. Rebel leader comes before queen for drink (5)
- 5. Died after even adrenal's finished (4)

PUZZLEBOMB: assembled by @stecks.

# PUZZLEBOMB

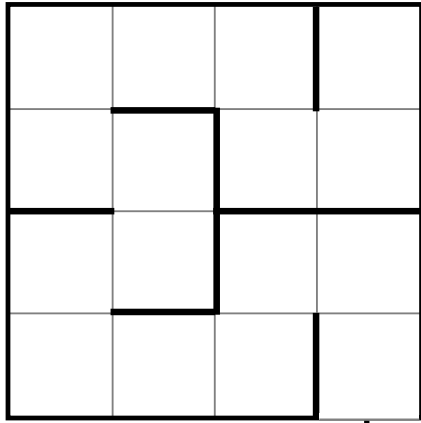

Numbers

Small mammal

Type of rock

Sacred

→ Moon study

## HILBERT'S SPACE FILLING CROSSWORD

HILBERT'S SPACE FILLING CROSSWORD:  
constructed by @apaultaylor.

# WATER FALL

Each circle sitting above two other circles contains the difference of the two below it. Fill the waterfall with the digits 0-9 so that all clues are satisfied when read in the correct orientation.

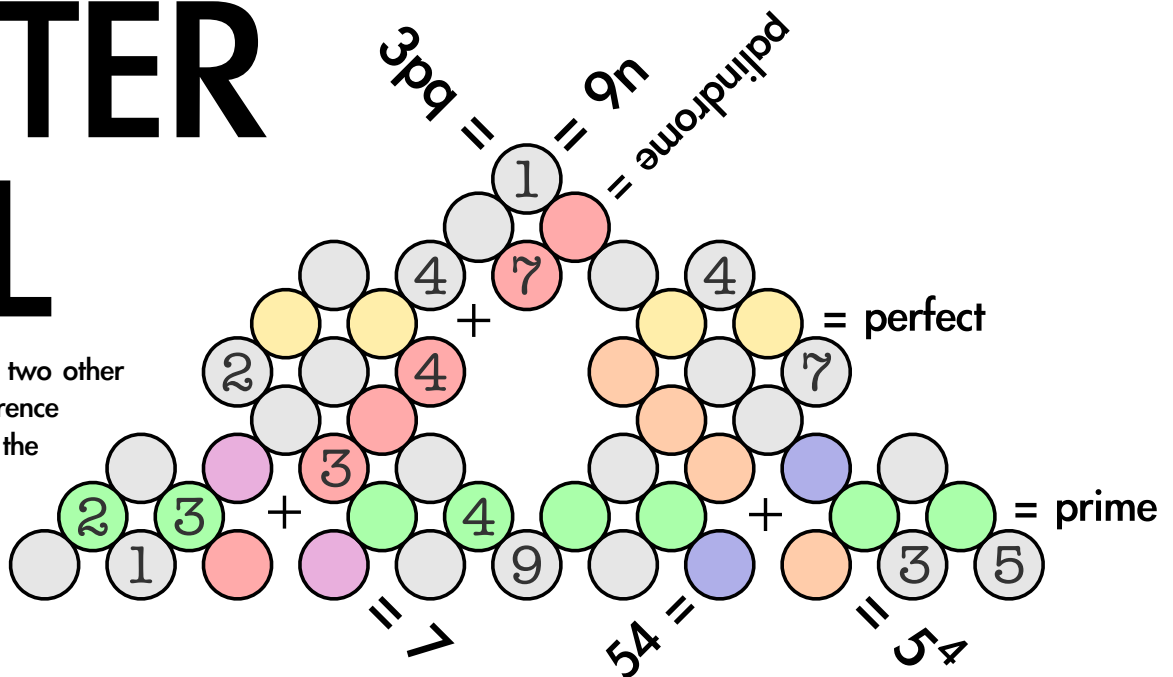

WATERFALL: devised by @stecks and @apaultaylor.

# APIS CLUES

Here are five cryptic crossword clues. You must solve the clues, then find the connection between the answers.

1. Garibaldi, for instance, offering tenner for rennet? (13)
2. Lutheran game show participant swaps bad point for good one (10)
3. Cow on common hardly spineless (8)
4. Unworldly one in approach to altar (5)
5. One's fallen from platform: looking back, it's tragic (3)

APIS CLUES: devised by @apisclues.

# PUZZLEBOMB

M	B	L	O	W	H	I	R	A	V
I	A	L	I	V	T	E	N	I	V
L	C	K	E	E	E	K	O	R	A
K	G	R	B	O	N	H	Y	P	P
Y	E	S	Y	A	K	I	S	A	L
E	N	N	O	W	Y	B	L	E	E

## WORD SPLIT

Divide the grid into 12 pieces of equal size and all of different shape, each containing a single word, and then colour appropriately.

WORDSPLIT:  
devised by @stecks.

## SPELLING BEES

In each honeycomb find two paths, starting and ending in coloured cells and visiting every cell once, that each spell out a word or phrase. The bee hides two different letters in each honeycomb.

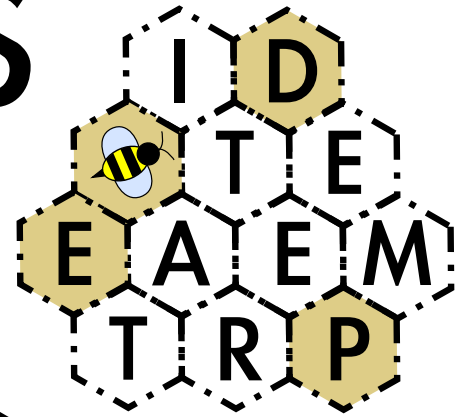

SPELLING BEES:  
devised by  
@apaultaylor.

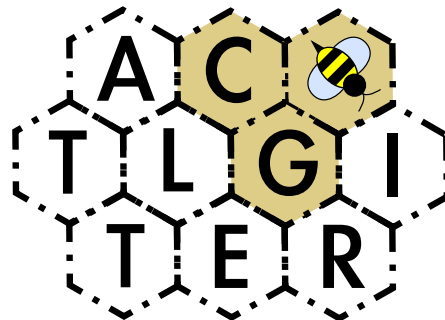
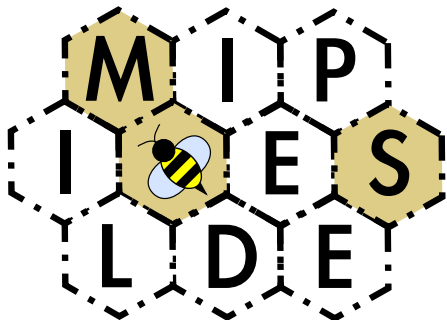

## APIS CLUES

Here are five cryptic crossword clues. You must solve the clues, then find the connection between the answers.

APIS CLUES: devised by @apisclues.

1. Get down - this already has (4)
2. Putting head to bottom in toilet: boring game (7)
3. My arse! More miserly? Not I (7)
4. Shark, pig-brained sort, perhaps, drank French sea (10)
5. Tough tactics confused Shakespeare in entryway (8)

PUZZLEBOMB: assembled by @stecks.

# PUZZLEBOMB

PRODUCTIVITY: devised by Chris M. Dickson  
 chris.dreamwidth.org

Range: 5 to 13

	550	624	756	
				480
				540
				1001

Range: 3 to 16

	135	70	143	48	40	42	96	
								12
								48
								70
								105
								130
								132
								144

Put the numbers from the given range into the grid (once each) so that an equal number of cells in each row and column are filled and the product of each row and column is the given value.

# PRODUCTIVITY

# SPELLING BEES

In each honeycomb find two paths, starting and ending in coloured cells and visiting every cell once, that each spell out a word or phrase. The bee hides two different letters in each honeycomb.

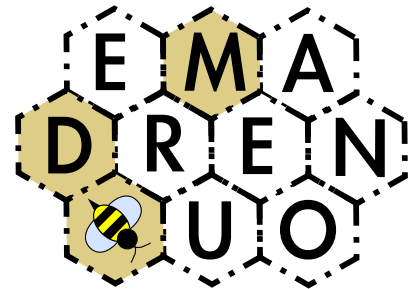
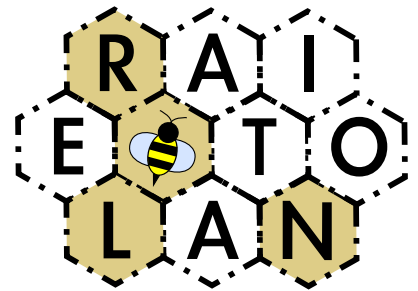

SPELLING BEES:  
 devised by @apaultaylor.

# APIS CLUES

Here are five cryptic crossword clues. You must solve the clues, then find the connection between the answers.

APIS CLUES: devised by @apisclues.

1. Fish key for chippy (9)
2. Flute perhaps Lance and Micah are playing (10)
3. Oil up Greek moderate (6)
4. Game's just the beginning for radio operators (4)
5. Painting is, at most, very slightly blue (11)

# PUZZLEBOMB

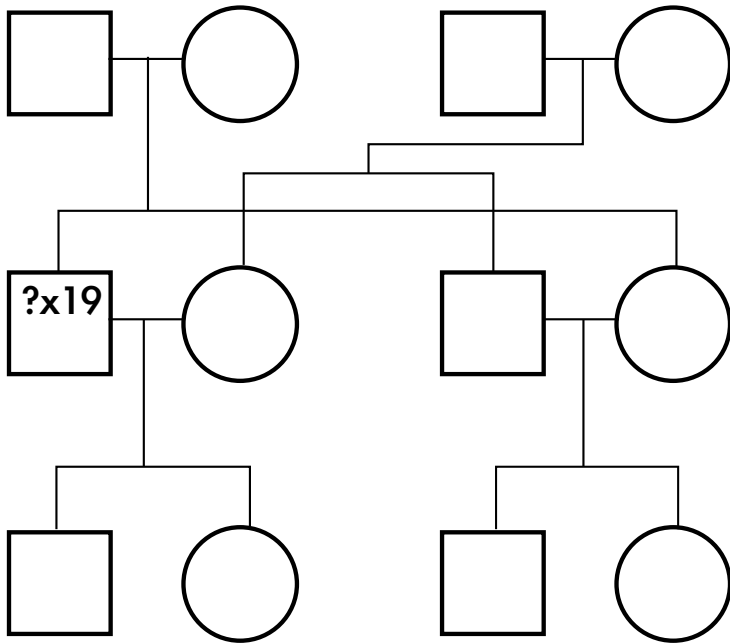

The fates of this family are controlled by their genes, which are each labelled by one of 8 distinct prime numbers. Each person has a pair of genes, inheriting one from each parent, and have no prime gene in common with their siblings.

Their age of death is precisely the product of their prime genes, never living more than 120 years, and in each of the six (adjacent) pairs, the women (circles) outlive the men (squares).

Can you work out how long each member of the family lived?

IN THEIR PRIME: devised by @outoffthenorm2.

## APIS CLUES

Here are five cryptic crossword clues. You must solve the clues, then find the connection between the answers.

APIS CLUES: devised by @apisclues.

1. Ocean where gold may be found without mining first (3)
2. Vermin swallowing backward Irish minister (6)
3. Disreputable stagecraft initially ignores unknown and keeps the best performers apart (5)
4. Betty Blind-Eye and Lucky Hearts playing the blues in Manchester (4)
5. Diplomats drunk a dram so after a fish supper? (11)

## SPELLING BEE

In each honeycomb find two paths, starting and ending in coloured cells and visiting every cell once, that each spell out a word or phrase. The bee hides two different letters.

SPELLING BEE:  
by @apaultaylor.



## IN THEIR PRIME

PUZZLEBOMB: assembled by @stecks.

# PUZZLEBOMB

## PATHWINDER

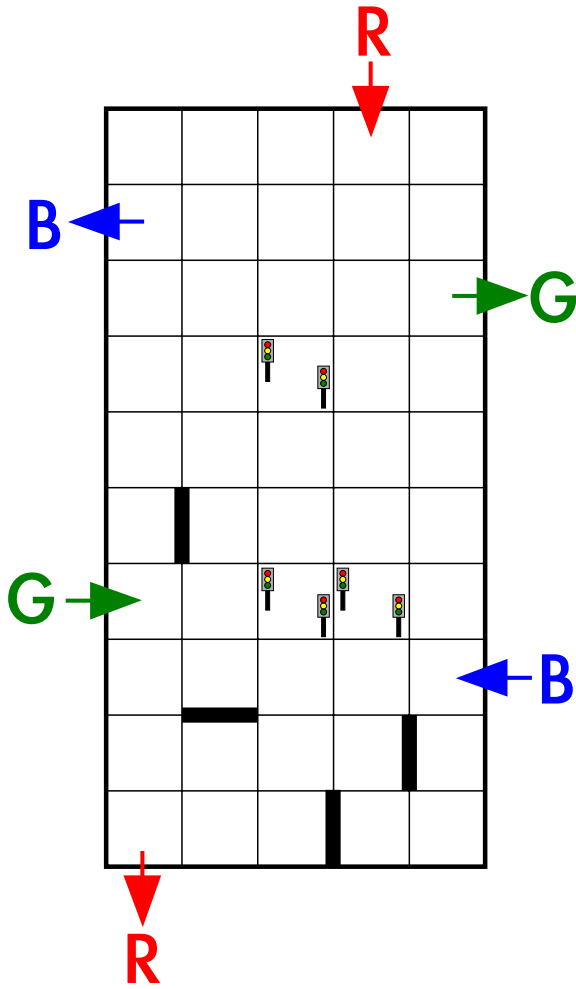

Robin, Brian and Goldacre can travel horizontally and vertically from square to square. Every square of the grid is used, and their paths may only cross at traffic lights - exactly one crossing (as shown) occurs between each pair.



Draw in the three paths through the grid.  
PATHWINDER: devised by @stecks.

## WORD SLIDE

WORD SLIDE:  
created by  
@PaulTaylor.

Definitions:

covered mourn player  
actors antelope computer

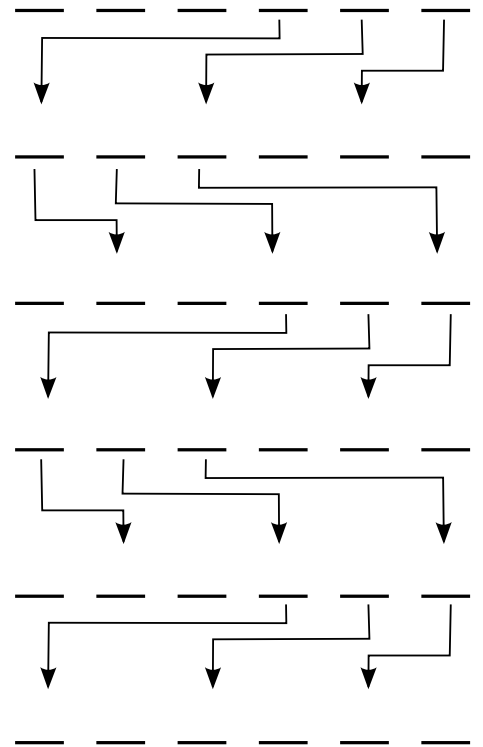

## APIS CLUES

Here are five cryptic crossword clues. You must solve the clues, then find the connection between the answers.

APIS CLUES: devised by @apisclues.

1. Naughty child brought before law's influence (6)
2. French bike approaching Paris at speed (8)
3. Obscure body in high position docks point on both sides (7)
4. Pub's coming in, according to letter (5)
5. First letter's stolen from sign - for starters, is that easy to catch? (6)



# PUZZLEBOMB

## WORD-A-TRON

Solve each section of the word-a-tron and use the resulting commands to trace out a hidden 5-letter word in the alphabet, starting from a letter to be determined.

			<p>Minimum number of colours needed?</p>	<p>TTTRIFH ELTHFHG LIGETRE FGHITFI GHLGREH IGTGTLH FLRTRTF ETERRTT IILELTF TTTRIFH ELTHFHG LIGETRE FGHITFI GHLGREH IGTGTLH FLRTRTF ETERRTT IIL</p> <p>Cancel and find the remainder!</p>			<p>Start with the number of:</p> <p>yes i reawaken (5,2,1,4)</p> <p>infuses dim quaver (5,4,7)</p> <p>huck ate beetroot (4,3,4,4)</p> <p>my innocent beer (9,2,3)</p> <p>tidy bow dive (6,2,3)</p>
<div style="border: 1px solid black; height: 80px;"></div>	<div style="border: 1px solid black; height: 80px;"></div>	<div style="border: 1px solid black; height: 80px;"></div>	<div style="border: 1px solid black; height: 80px;"></div>	<div style="border: 1px solid black; height: 80px;"></div>	<div style="border: 1px solid black; height: 80px;"></div>	<div style="border: 1px solid black; height: 80px;"></div>	<div style="border: 1px solid black; height: 80px;"></div>

WORD-A-TRON: devised by @stecks & @mathsjam/MCR.

## APIS CLUES

Here are five cryptic crossword clues. You must solve the clues, then find the connection between the answers.

APIS CLUES: devised by @apisclues.

1. Deep moo (3)
2. At this point, duck is accepted in second Justice League of America (6)
3. Spoken after church in relation to the choir (6)
4. Pu allows Nianzu to begin to overcome uncertainty regarding the underworld (9)
5. Early Mexican fool probed by alien in the wrong direction (6)

PUZZLEBOMB: assembled by @stecks.

# PUZZLEBOMB

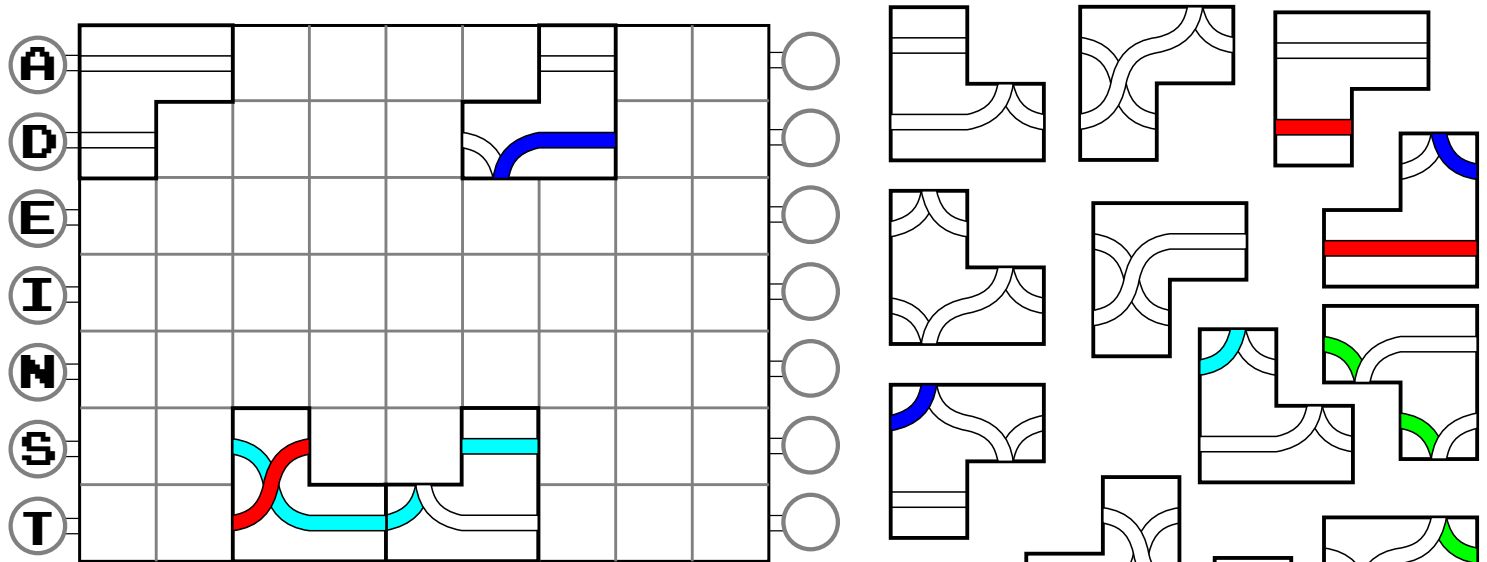

The circuitry for this word display was accidentally dismantled before the engineer could finish colouring in the wires. Reassemble the pieces into the circuitry grid (without rotations) and determine what is spelt on the word display.

CIRCUIT TRAINING:  
devised by @stecks.

## CIRCUIT TRAINING

Identify who is speaking, and determine their initial field of study.

MISQUOTED:  
by @stecks.

## MISQUOTED

"Do not worry about your difficulties; an admirable proof of this is the sum of the squares on the other two, and all the rest is the work of an equal and opposite royal road to geometry, so profoundly the spirit of man." - ? ? ? ? ? ? ?

## APIS CLUES

Here are six cryptic crossword clues. You must solve the clues, then find the connection between the answers.

APIS CLUES: devised by @apisclues.

1. Partners black British comedian (4)
2. You no-good children (5)
3. Substitute loses it, one who worked hard for Saint Clair (4)
4. Connect down the line to Tape director (9)
5. Gareth from The Office's horrible maize neck (9)
6. Author, merciless one, consumed by university course (9)

# PUZZLEBOMB

- Seven letter word, perhaps
- Religious pronouncement
- Gas and oil, eg.
- Coating
- Organs
- Form of address
- Negative
- Relative
- Spirit, enthusiasm
- Disgusting

**MAGIC  
WORD**

created by @gheizhwinder.  
MAGIC WORD:

These squares need a word to make them magic! Solve the clues and fit the words in the squares as indicated, so that each row of the right grid is the corresponding row of the left grid encoded by a letter via the Caesar cipher, to give a thematic magic word down the middle.

## APIS CLUES

Here are five cryptic crossword clues. You must solve the clues, then find the connection between the answers.

APIS CLUES: devised by @apisclues.

1. Wilson kept back after class to have silly ideas heartlessly knocked out, producing strong grasp (5)
2. Bad time to go back to Scouts? (5)
3. Fasten scarf (4)
4. Cocaine runs out early, right, because you do this too much? (5)
5. Mist obscures all but the bottom part of laurel tree (5)

# PUZZLEBOMB

## WINTER FALL

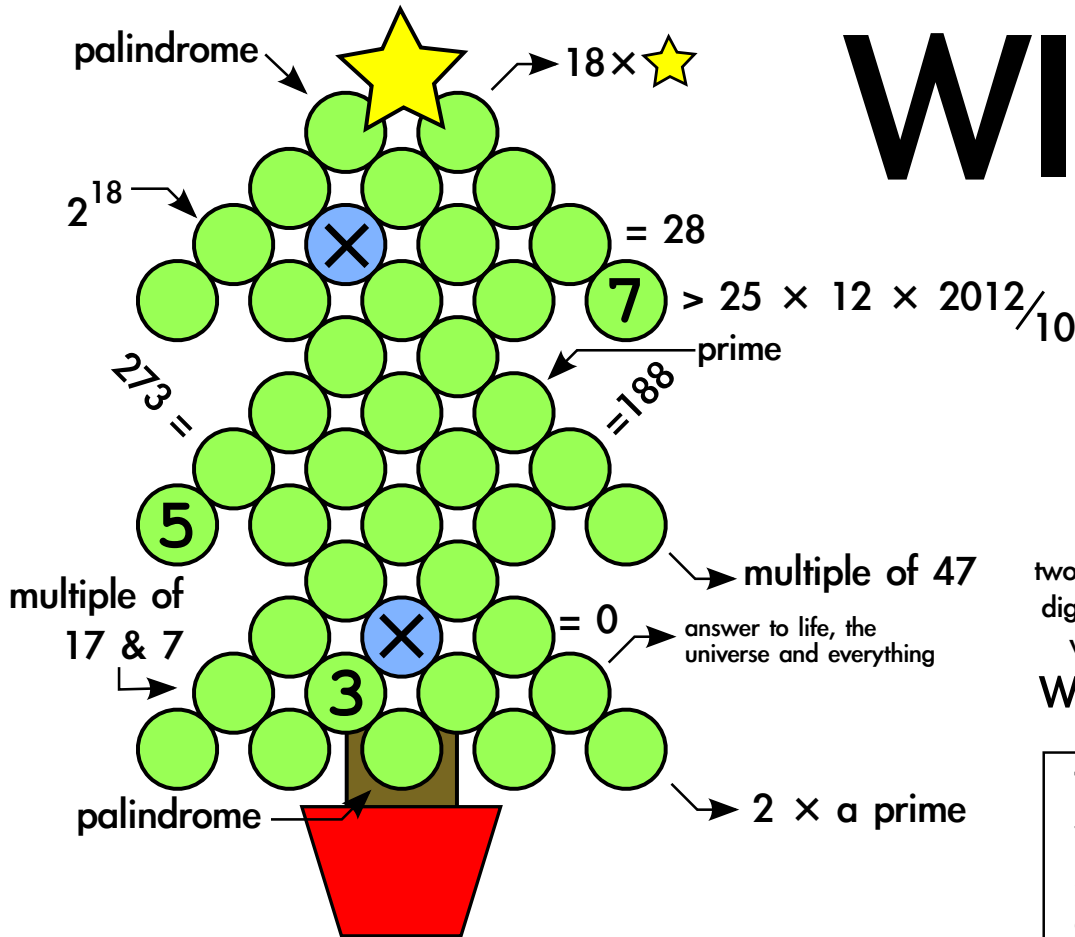

Based on the WATERFALL from the April 2012 edition of Puzzlebomb. Each circle sitting above two other circles contains the difference of the two below it. Fill the winterfall with the digits 0-9 so that all clues are satisfied when read in the correct orientation. **WINTERFALL:** by @stecks.

Thanks for reading a whole year of PUZZLEBOMB! Please send your puzzle ideas and comments to @stecks.

## THE BAUBLE CODE

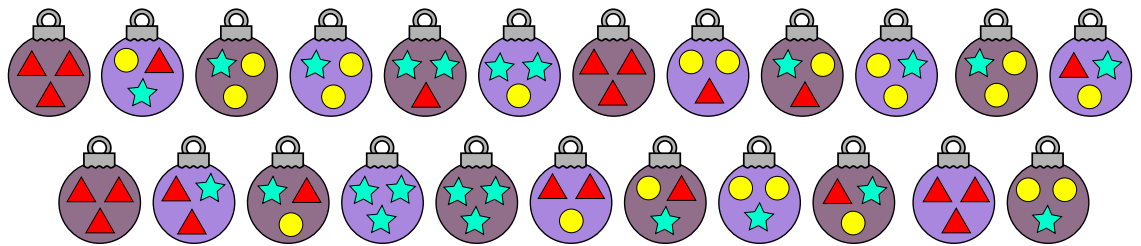

Decode the secret message. **THE BAUBLE CODE:** devised by @christianp.

## APIS CLUES

Here are six cryptic crossword clues. You must solve the clues, then find the connection between the answers.

APIS CLUES: devised by @apisclues.

1. What might be said before hanging up - a fine deal for one listening in? (7)
2. "One to nothing for Murray", you said to your partner? (1,4,3)
3. Affirmation for Merkel amidst sound of uncertainty, after the French in room give a word of praise (10)
4. "Endure torrents" mistaken for postal service catchphrase (6,2,6)
5. Noel's friend Miller heartlessly left encased in copper (2,6)