

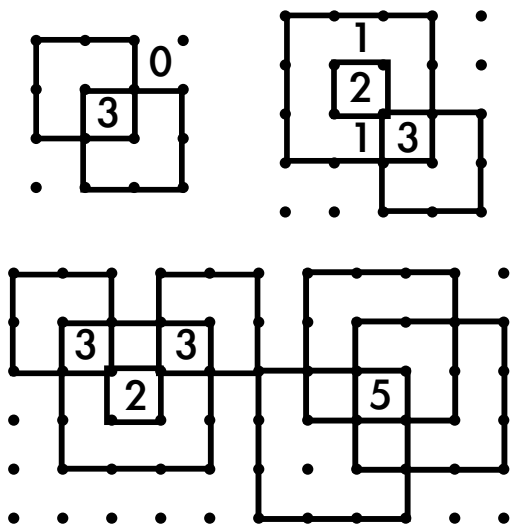

PUZZLEBOMB SOLUTIONS

SHIKAKU



SHIKAKU: invented by @andrew_taylor.

V ¹	L	A	I	R	N	E	U ²	S
I ³	R	U	E ⁴	A	S	V	L	N
⁵ N	E ⁶	S	U	L	V ⁷	I	R	A
E	A	L	S	I	U	N ⁸	V	R
⁹ U	N	I	V	E	R	S	A	L
R	S ¹⁰	V	A	N ¹¹	L	U	I	E
A	V	E	R	S	I	L	N	U
L	I	R ¹²	N	U	E	A	S	V
¹³ S	U	N	L ¹⁴	V	A	R	E	I

CLUDOKU

CLUDOKU: Copyright Richard Crawford (@RickCrawf).

APIS CLUES

devised by @apisclues.

1. Victory after radical turn for naturalist - DARWIN
2. Ondaatje suspected of harbouring prophet - JESUS
3. PM: you are briefly stammering 'Cold outside' - CHURCHILL
4. Poet losing time from wine - CLARE
5. No.2's follower made angel queer - MAGDALENE

The connection: these are all colleges of the University of Cambridge.

PUZZLEBOMB

SOLUTIONS

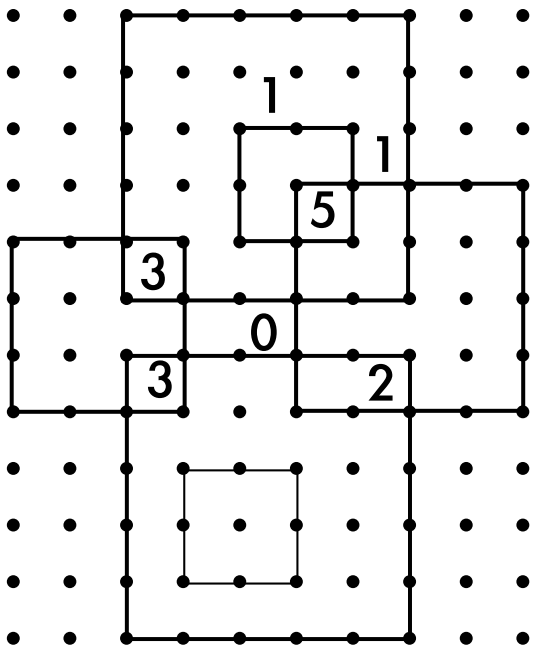

HEI
HOU

(Drawn squares are shaded)

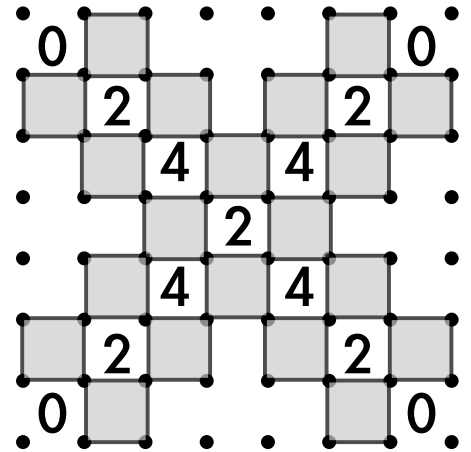

HEIHOU: Invented by @Andrew_Taylor.

TINY LISTENER

TINY LISTENER: Devised by @aPaulTaylor and @stecks.

- | | |
|---------|---------|
| ACROSS | DOWN |
| 1. WON | 1. WAFT |
| 3. WITH | 2. AWES |
| 5. SEIF | 4. SIR |
| 6. ARIA | |

S	N	O	W
W	H	I	T
E	I	S	F
A	I	R	A

- Scandinavian ruler almost completely engrossed by middlingly lavish herring's tail - VIKING
- Measure three-and-a-bit about group of countries - EMPIRE
- Hugo perhaps briefly blue after triumph - VICTORY
- Chance for melody - FORTUNE
- Look after insect queen - MOTHER

APIS CLUES

Devised by @apisclues.

The connection: these are all varieties of apple.

PUZZLEBOMB

SOLUTIONS

SOLUTION PATH

4dn can only be 512; 8ac, 21ac/dn can only be 59/42/45; 11ac = 21ac backwards → 24; 18dn = 5---/24 + --- → 200 < 18dn < 250; 23ac = 15ac x 20 so 23ac ends -50 and 15ac ends -5; 17ac forces 16dn = 5020, so 17ac = 71; 16dn factors sum gives 5564 is an entry, which can only be 1dn; 17dn must be 729; 22ac = 9--- means 23ac = 150 and gives 22ac; clue for 23ac means 15ac = 15; 4ac clue forces 4ac = ---5; clue for 15ac forces 18dn in {220, 250, 280} but only 220 works for 4ac; 4ac now given; 220 in shaded entry means 284 must appear; clue for 7dn rules out 13ac, so only one spot left; 6dn can only be 94210; 3dn forced; 1184 forces 1210; 13ac forced, so is 7dn; 14dn, 19dn forced (note digit sum) gives 2620, giving 2924; only 47/27110 works for 12ac/10dn; 1ac, 2dn forced.

¹ 5	² 7	³ 1	⁴ 5	⁵ 2	⁶ 9	⁷ 5
⁸ 5	9	⁹ 1	1	8	4	0
6	¹⁰ 2	9	2	4	¹¹ 2	4
¹² 4	7	¹³ 4	9	¹⁴ 6	¹⁵ 1	¹⁶ 5
¹⁷ 7	1	¹⁸ 2	¹⁹ 6	2	0	0
2	²⁰ 1	2	1	0	²¹ 4	2
²² 9	0	0	2	²³ 1	5	0

NUMBERWARG: devised by @apaultaylor and @stecks.

NUMBERWARG

APIS CLUES

APIS CLUES: devised by @apisclues.

1. Musical in which Nazis are on the tail of revolutionary - CHESS
2. Gold cent stolen from plate before Monday's lesson - SERMON
3. Lost fellow's heartless, it's reported - SAID
4. Rebel leader comes before queen for drink - WATER
5. Died after even adrenal's finished - DEAD

These are the last words of the titles of the five parts of The Waste Land by T. S. Eliot: The Burial of the DEAD, A Game of CHESS, The Fire SERMON, Death by WATER and What the Thunder SAID.

PUZZLEBOMB: assembled by @stecks.

PUZZLEBOMB

SOLUTIONS

O	N	E	S
M	O	L	E
P	R	O	G
H	O	L	Y

HILBERT'S SPACE FILLING CROSSWORD

HILBERT'S SPACE FILLING CROSSWORD:
constructed by @apaultaylor.

WATERFALL

WATERFALL: devised by
@stecks and @apaultaylor.

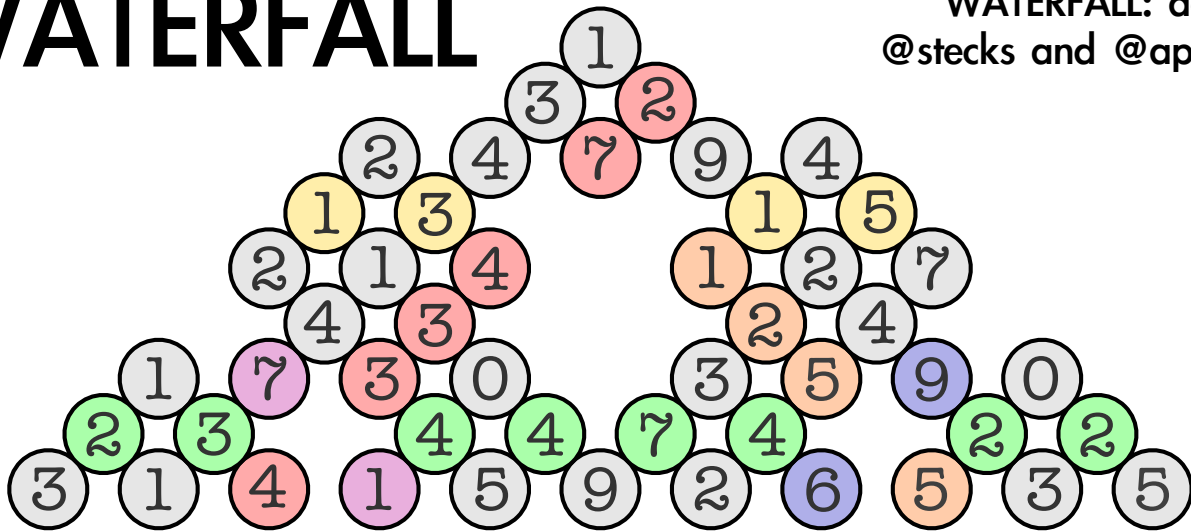

APIS CLUES

These are things associated with the first five colours of the rainbow; red, orange, yellow, green and blue.

1. Garibaldi, for instance, offering tenner for rennet? - REVOLUTIONARY
2. Lutheran game show participant swaps bad point for good one - PROTESTANT
3. Cow on common hardly spineless - COWARDLY
4. Unworldly one in approach to altar - NAIVE
5. One's fallen from platform: looking back, it's tragic - SAD

APIS CLUES: devised by @apisclues.

PUZZLEBOMB SOLUTIONS

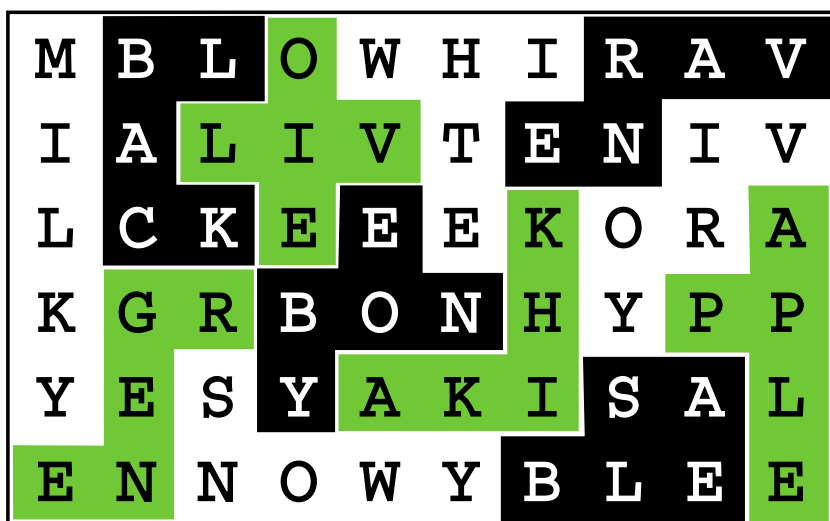

WORD SPLIT

WORDSPILT: devised by @stecks.

SPELLING BEES

MILLIPEDES
SPEED LIMIT

CATTLE GRID
CLATTERING

PREMEDITATED
DISTEMPERATE

SPELLING BEES:
devised by
@apaultaylor.

APIS CLUES

DUCK, BULLDOG, STINGER, HAMMERHEAD and HARDBALL are all callsigns of minor characters in the 're-imagined' Battlestar Galactica.

APIS CLUES: devised by @apisclues.

1. Get down - this already has - DUCK
2. Putting head to bottom in toilet: boring game - BULLDOG
3. My arse! More miserly? Not I - STINGER
4. Shark, pig-brained sort, perhaps, drank French sea - HAMMERHEAD
5. Tough tactics confused Shakespeare in entryway - HARDBALL

PUZZLEBOMB SOLUTIONS

Range: 5 to 13

5	8	12	480
10	6	9	540
11	13	7	1001

Range: 3 to 16

			4		3		12
				8		6	48
				5	14		70
15	7						105
	10	13					130
		11	12				132
9						16	144

PRODUCTIVITY:
devised by Chris M. Dickson
chris.dreamwidth.org

PRODUCTIVITY

SPELLING BEES

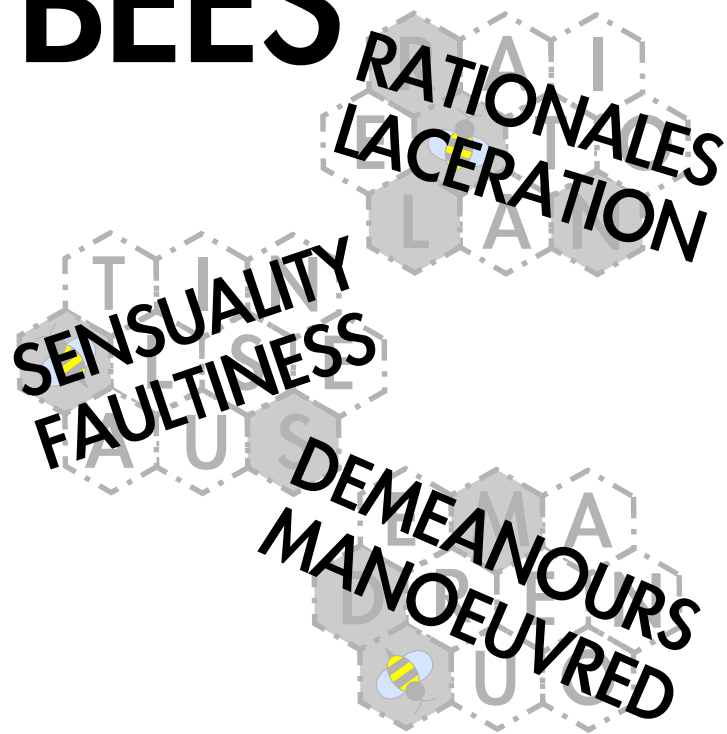

SPELLING BEES:
devised by @apaultaylor.

APIS CLUES

CARPENTER, MECHANICAL, GREASE, GOLF and WATERCOLOUR are all kinds of PENCIL.

APIS CLUES: devised by @apisclues.

1. Fish key for chippy - CARPENTER
2. Snug, possibly insane artisan's first to get out when well-paid American comes back inside - MECHANICAL
3. Oil up Greek moderate - GREASE
4. Game's just the beginning for radio operators - GOLF
5. Painting is, at most, very slightly blue - WATERCOLOUR

PUZZLEBOMB: assembled by @stecks.

PUZZLEBOMB SOLUTIONS

SPELLING BEE

SPELLING BEE:
by @apaultaylor.

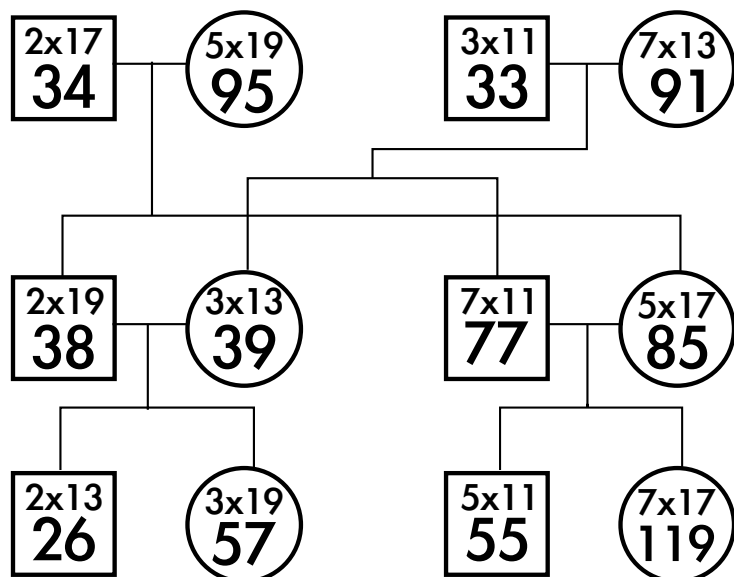
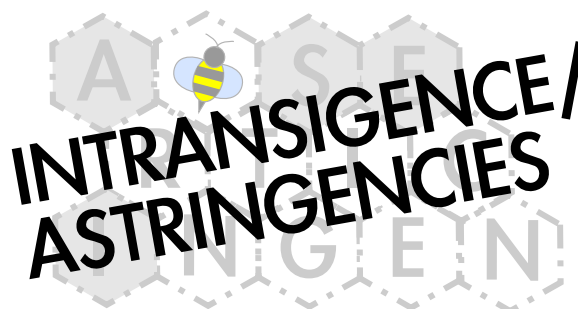

IN THEIR PRIME

IN THEIR PRIME:
devised by @outofthenorm2.

APIS CLUES

APIS CLUES:
by @apisclues.

SEA, PRIEST, SEEDS,
CITY, AMBASSADORS:
they have all been
'of Death' in the titles
of Doctor Who
episodes or stories.

1. Ocean where gold may be found without mining first - SEA
2. Vermin swallowing backward Irish minister - PRIEST
3. Disreputable stagecraft initially ignores unknown and keeps the best performers apart - SEEDS
4. Betty Blind-Eye and Lucky Hearts playing the blues in Manchester - CITY
5. Diplomats drunk a dram so after a fish supper? - AMBASSADORS

PUZZLEBOMB SOLUTIONS

PATHWINDER

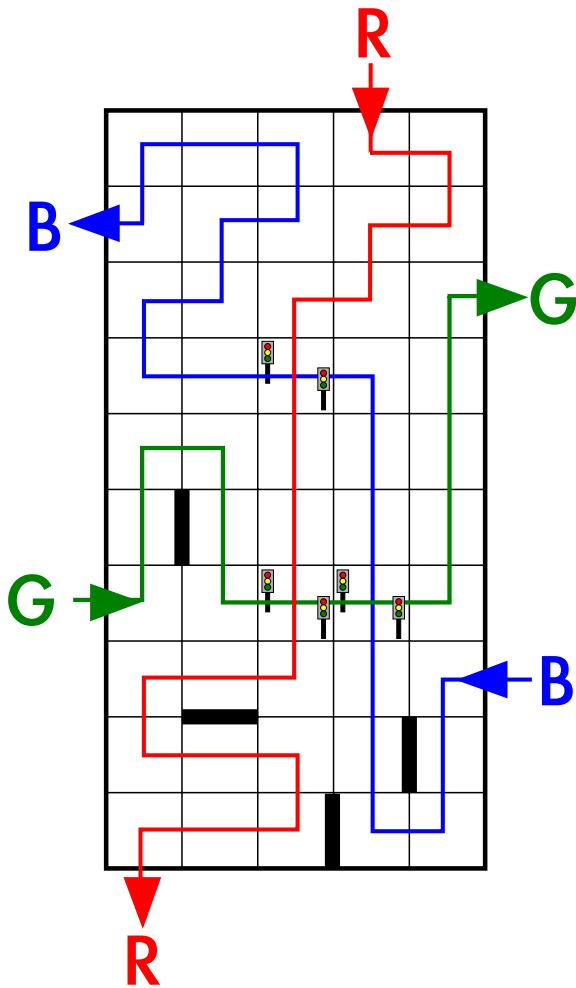

PATHWINDER: devised by @stecks.

WORD SLIDE

WORD SLIDE:
created by
@apaultaylor

computer = l a p t o p
 actors = t r o u p e
 player = s t e r e o
 antelope = r e e b o k
 mourned = g r i e v e
 coveted = e n v i e d

APIS CLUES

APIS CLUES:
devised by @apisclues.

IMPACT, VELOCITY, ECLIPSE, ALPHA and IGNITE are all team names from The Apprentice (series 1 to 5 respectively.)

1. Naughty child brought before law's influence - IMPACT
2. French bike approaching Paris at speed - VELOCITY
3. Obscure body in high position docks point on both sides - ECLIPSE
4. Pub's coming in, according to letter - ALPHA
5. First letter's stolen from sign - for starters, is that easy to catch? - IGNITE

PUZZLEBOMB

SOLUTIONS

WORD-A-TRON

			<p>Minimum number of colours needed = 3</p>	<p> * * * * * H E * * * * H G * * * G * * R E * G H * * * * * G H * G * R E H * G * G * * * H F * L * R * * * * E * * * * R * * * * * * * * * E * * * * * * * * * R * * * * E * * * * * H E * * * * * H G * * * G * * R E * G H * * * * * G H * G * R E H * G * G * * * H F * L * R * * * * E * * * * R * * * * * * * * * R * * * * * * * * * T * I * </p> <p>13 x L, E, F, T 14 x R, I, G, H, T</p> <p>RIGHT</p>	<p>ROFL -</p> <p>LOL WTF OMG U</p> <p>1732 -</p> <p>272 583 774 8</p> <p>= 19</p>		<p>Anagrams unscrambled:</p> <p>weeks in a year (= 52)</p> <p>minus five squared (= 27)</p> <p>take the cube root (= 3)</p> <p>increment by one (= 4)</p> <p>divide by two (= 2)</p>
--	--	--	---	--	---	--	--

Left 13, Left 3, Right 19, Left 2

Answer is R-E-B-U-S

WORD-A-TRON: devised by @stecks & @mathsjam/MCR.

APIS CLUES

APIS CLUES: devised by @apisclues.

LOW, HEROES, CHORAL, PLUTONIAN (Ode) and TOLTEC are the symphonies of Philip Glass. They're not all Bowie albums. Sorry about that.

1. Deep moo - LOW
2. At this point, duck is accepted in second Justice League of America - HEROES
3. Spoken after church in relation to the choir - CHORAL
4. Pu allows Nianzu to begin to overcome uncertainty regarding the underworld - PLUTONIAN
5. Early Mexican fool probed by alien in the wrong direction - TOLTEC

PUZZLEBOMB SOLUTIONS

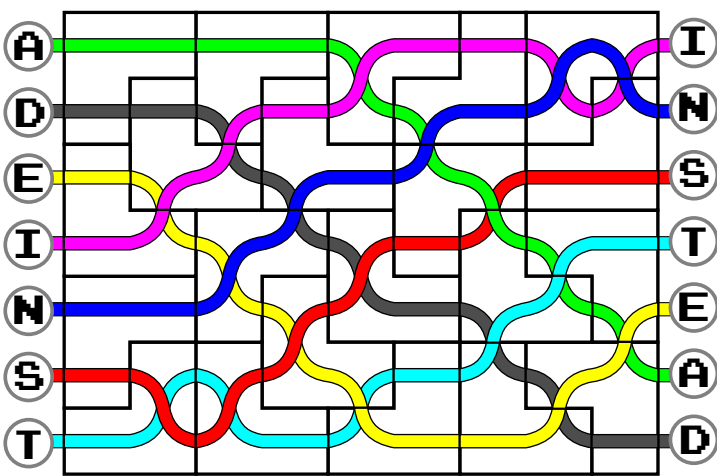

CIRCUIT TRAINING

CIRCUIT TRAINING:
devised by @stecks.

MISQUOTED

- "Do not worry about your difficulties in mathematics, I assure you that mine are greater." - Albert Einstein
- "I have assuredly found an admirable proof of this, but the margin is too narrow to contain it." - Pierre De Fermat
- "The square on the hypotenuse is the sum of the squares on the other two sides." - Pythagoras
- "God created the natural numbers, and all the rest is the work of man." - Leopold Kronecker
- "To every action there is always an equal and opposite reaction." - Isaac Newton
- "There is no royal road to geometry." - Euclid
- "The infinite! No other question has ever moved so profoundly the spirit of man." - David Hilbert

= APPLIED

APIS CLUES

APIS CLUES: devised by @apisclues.

WEBB, YOUNG, ERTZ,
LINKLATER, MACKENZIE
and HEMINGWAY
authored the first six
orange Penguin books.

1. Partners black British comedian - WEBB
2. You no-good children - YOUNG
3. Substitute loses it, one who worked hard for Saint Clair - ERTZ
4. Connect down the line to Tape director - LINKLATER
5. Gareth from The Office's horrible maize neck - MACKENZIE
6. Author, merciless one, consumed by university course - HEMINGWAY

PUZZLEBOMB

SOLUTIONS

→	M	I	N	U	S
→	M	A	D	A	M
→	V	E	R	V	E
→	F	A	T	W	A
→	Y	U	K	K	Y

S
H
I
F
T

↓	↓	↓	↓	↓
F	B	G	N	L
U	I	L	I	U
E	N	A	E	N
L	G	Z	C	G
S	O	E	E	S

- Seven letter word, perhaps - BINGO
- Religious pronouncement - FATWA
- Gas and oil, eg. - FUELS
- Coating - GLAZE
- Organs - LUNGS
- Form of address - MADAM
- Negative - MINUS
- Relative - NIECE
- Spirit, enthusiasm - VERVE
- Disgusting - YUKKY

MAGIC WORD

MAGIC WORD:
created by @gheizhwinder.

APIS CLUES

CLAMP, TROOP, BOLT, SNORT & HAZEL all live in Trumptonshire!

APIS CLUES: devised by @apisclues.

1. Wilson kept back after class to have silly ideas heartlessly knocked out, producing strong grasp - CLAMP
2. Bad time to go back to Scouts? - TROOP
3. Fasten scarf - BOLT
4. Cocaine runs out early, right, because you do this too much? - SNORT
5. Mist obscures all but the bottom part of laurel tree - HAZEL

PUZZLEBOMB

SOLUTIONS

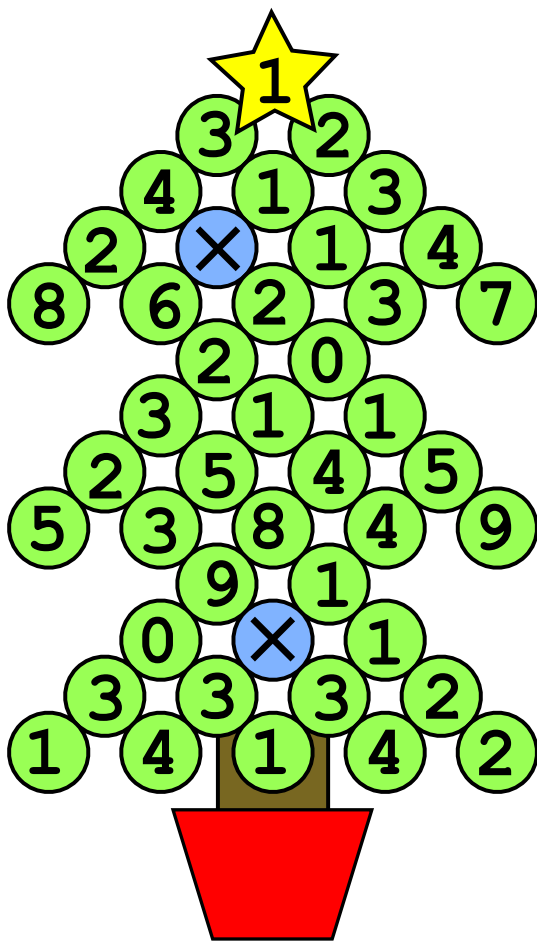

WINTERFALL

WINTERFALL: by @stecks.

THE BAUBLE CODE

Each bauble contains a number written in ternary, where a circle represents 0, a triangle is 1 and a star is 2, read from the top left. Having found the number, convert to a letter using A=1, B=2 etc. to find the message below.

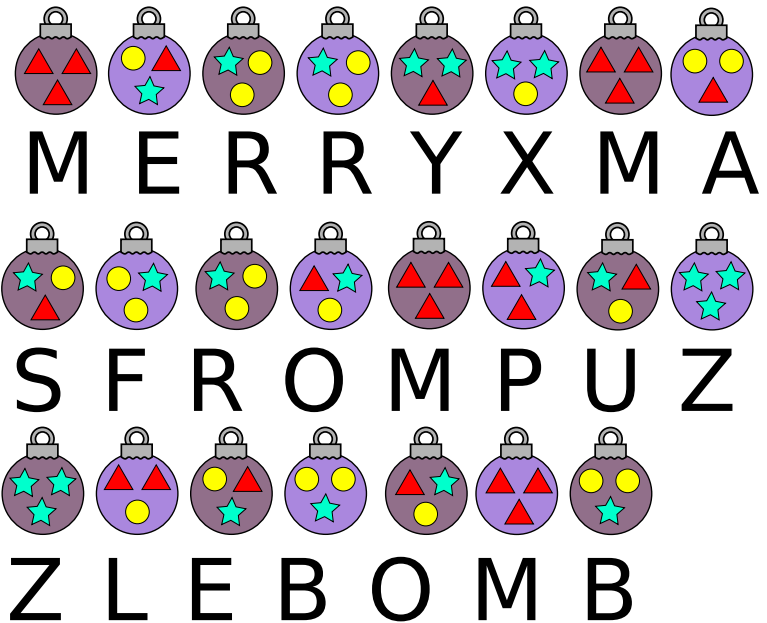

THE BAUBLE CODE: devised by @christianp.

APIS CLUES

GOODBYE, I LOVE YOU, HALLELUJAH, RETURN TO SENDER and MR BLOBBY are all the titles of UK Christmas number ones.

APIS CLUES: devised by @apisclues.

1. What might be said before hanging up - a fine deal for one listening in? - GOODBYE
2. "One to nothing for Murray", you said to your partner? - I LOVE YOU
3. Affirmation for Merkel amidst sound of uncertainty, after the French in room give a word of praise - HALLELUJAH
4. "Endure torrents" mistaken for postal service catchphrase - RETURN TO SENDER
5. Noel's friend Miller heartlessly left encased in copper - MR BLOBBY

PUZZLEBOMB: assembled by @stecks.